



GC100/GC102 • *Embedded Gold*

AI Edge Computing Platform

NVIDIA® Jetson Xavier™ NX

Wi-Fi & WWAN • PCIe® Optical Cabling

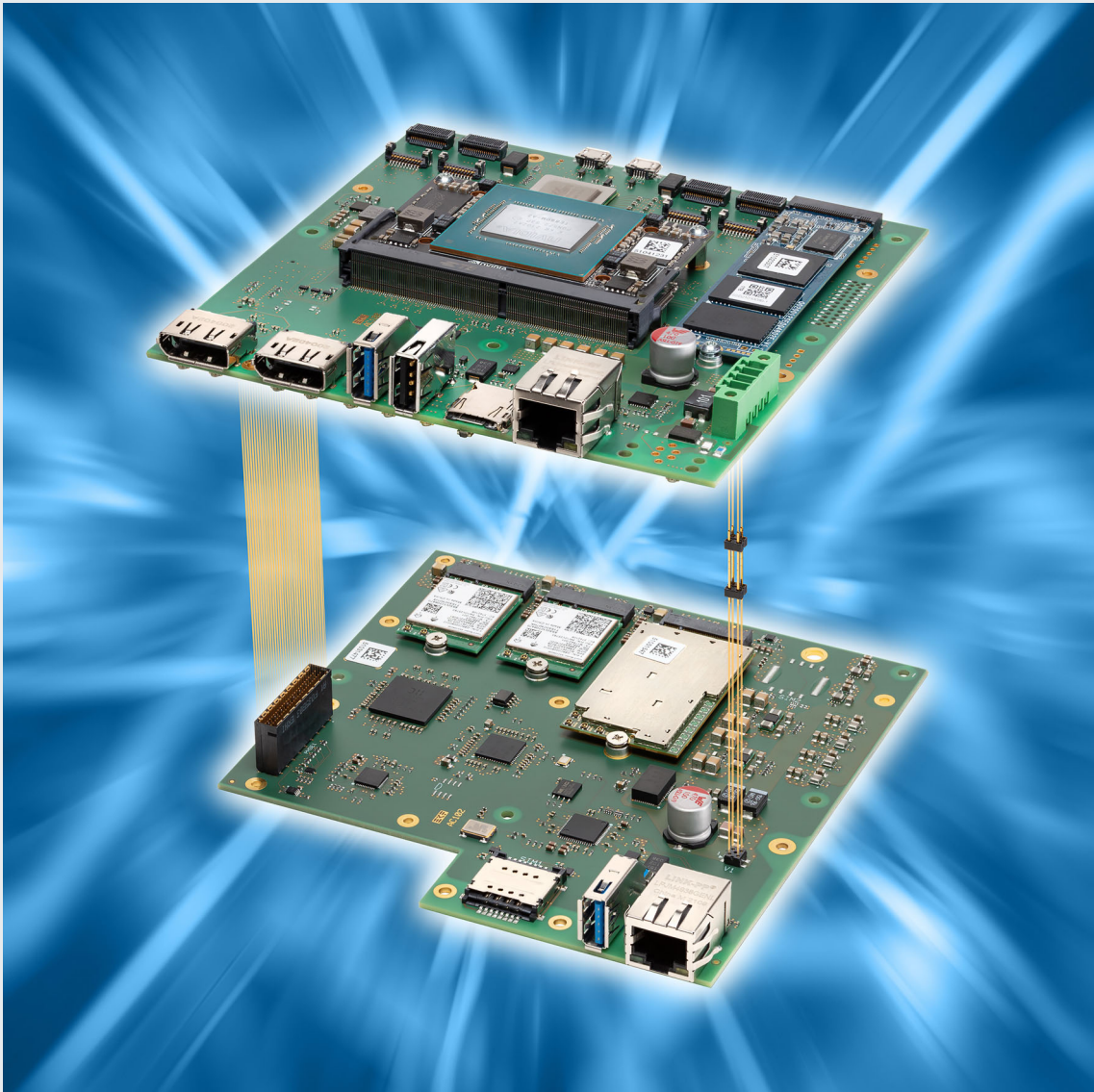

Overview

The GC100 is a Single-Board-Computer intended for AI and real-time edge computing. Equipped with the Nvidia® Jetson Xavier™ NX SoM, the board was designed for rugged industrial applications such as IIoT or image processing.

The GC100 SBC provides typical I/O connectors, e.g. DisplayPort, Ethernet, and USB. A PCIe® M.2 SSD is available as on-board mass storage.

The GC100 comes with the L4T (Linux for Tegra) development suite by Nvidia®, customized by EKF.

For wireless networking, the GC100 can be paired with the matching GC102 mezzanine card, equipped with M.2 connectors for 4G/5G WWAN and dual Wi-Fi 6 modules.

The GC100 SBC can be configured as master or slave in distributed multi-processing applications. For this purpose the board is provided with four Samtec FireFly™ Flyover® connectors, each suitable for a PCI Express® Gen3 x4 based fiber optical cable up to 100m, or Twinax copper cable assembly. Moreover, the PCIe® interfaces can also be used for attachment of demanding peripheral devices such as high resolution cameras.

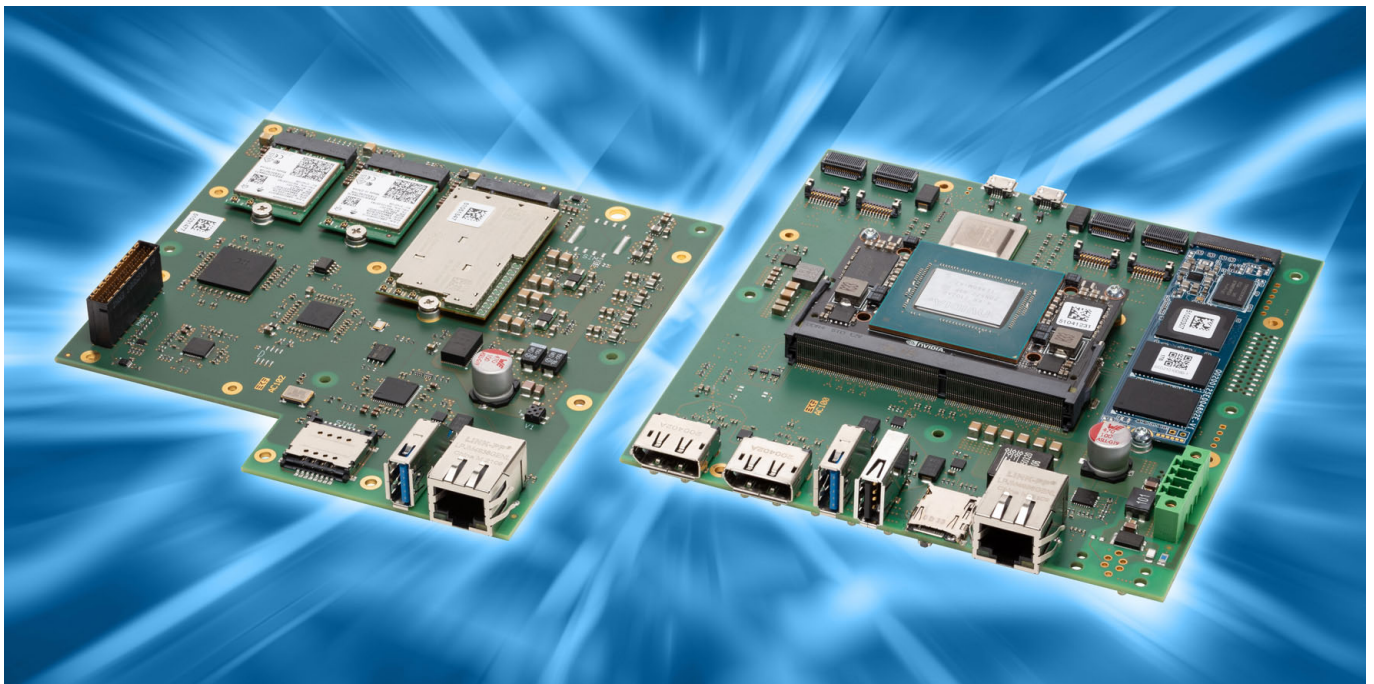

FireFly™ Flyover®

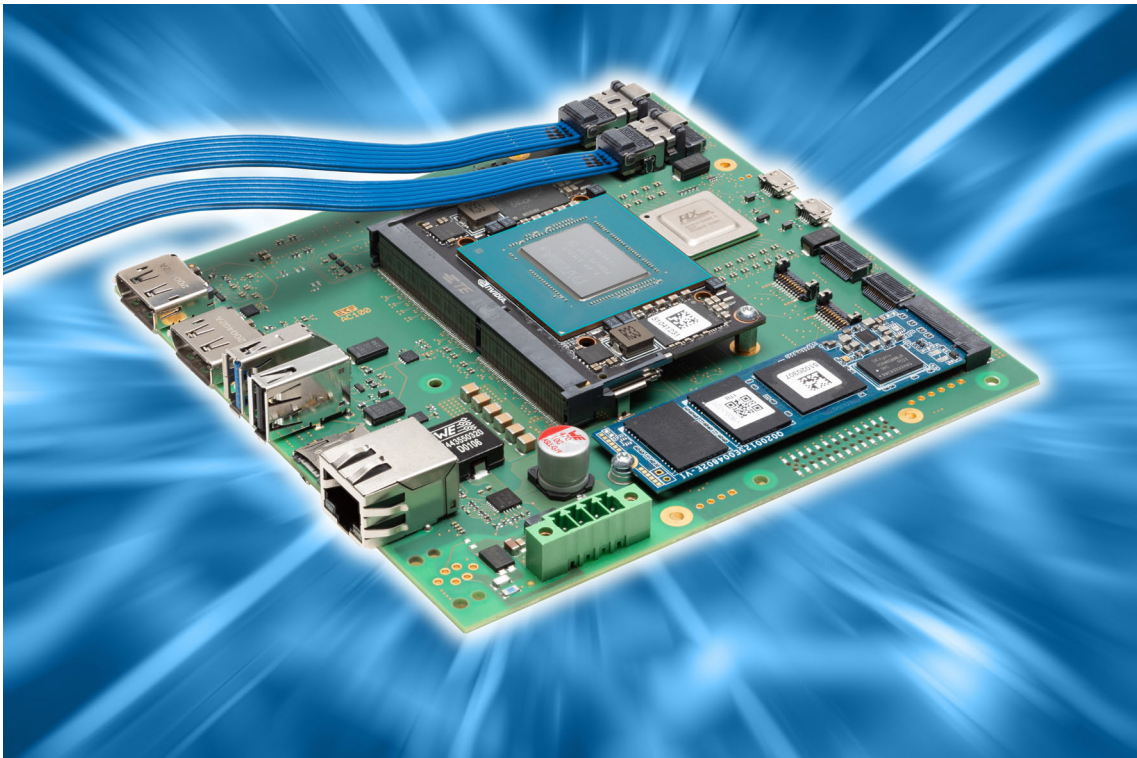
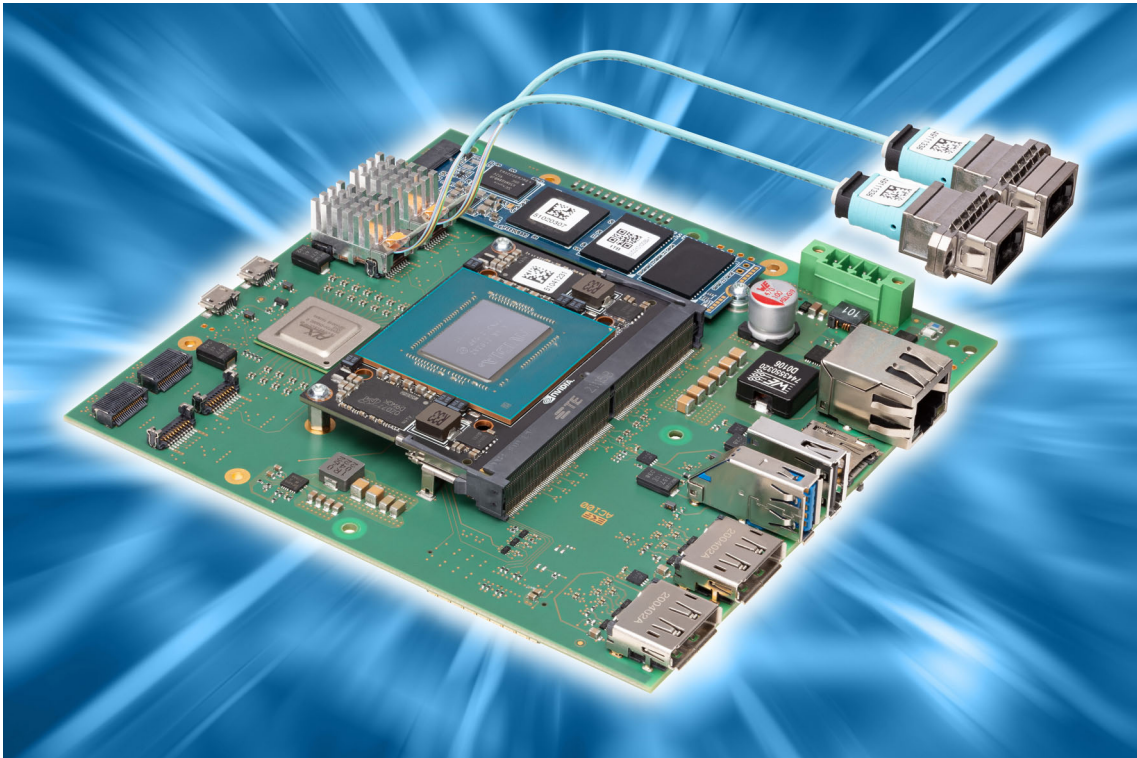

Technical Features

General

- ▶ NVIDIA® Jetson Xavier™ NX based platform
- ▶ Single or dual PCB assembly
- ▶ Intended for rugged industrial applications, ready-for-use (*Embedded Gold*)
- ▶ Industrial PCB assembly - basic board GC100 and optional expansion board GC102
- ▶ PCB Dimensions 138.0mm x 133.0mm
- ▶ M.2 NVMe SSD socket
- ▶ Up to 4 x PCI Express® x4 MPO/MTP optical cabling ports
- ▶ Versatile standard front I/O connector suite (DisplayPort, USB, GbE)
- ▶ Option dual Wi-Fi 6 modules (GC102)
- ▶ Option WWAN 4G/5G module (GC102)
- ▶ Option SMA/SMA-RP antenna connectors (GC102)
- ▶ M12 power connector
- ▶ Option terminal block power connector
- ▶ 9-57VDC wide range power input operation

Front I/O

- ▶ Dual DisplayPort connectors
- ▶ Up to 2 x RJ45 Gigabit Ethernet jacks
- ▶ Up to 3 x USB Type-A receptacles
- ▶ Micro SD Card slot
- ▶ Up to 4 x MPO/MTP optical ports for PCIe® external cabling
- ▶ Option antenna connectors SMA/SMA-RP WLAN/WWAN (GC102)
- ▶ Dual slot Micro SIM Card (GC102)
- ▶ M12-A DC front power connector
- ▶ Option ATX auxiliary power connector
- ▶ Option terminal block 3.5mm pitch 4-position screw lock (side of PCB) power input

System-on-Module

- ▶ NVIDIA® Jetson Xavier™ NX
- ▶ AI performance up to 21 TOPS
- ▶ Volta GPU, 384 CUDA® cores, 48 Tensor cores, max. 1100MHz
- ▶ Carmel CPU, ARMv8.2, 3x dual-core CPU clusters (six NVIDIA Carmel processor cores), max. 1900 MHz
- ▶ Memory 8GB/16GB LPDDR4 DRAM, 1600MHz
- ▶ Storage 16GB eMMC 5.1 200 MHz (HS400)
- ▶ Display controller 2 x DP 1.4 up to 3840x2160 at 60 Hz, video H.265 decode/encode
- ▶ PCI Express® 1x4, 1x1 (root hub or endpoint device configurable)
- ▶ Variety of I/O e.g. USB, Gigabit Ethernet, SD Card slot
- ▶ 10W/15W/20W operating modes

Technical Features

Software Development

- ▶ L4T (Linux for Tegra) development suite by Nvidia®
- ▶ Customization by EKF
- ▶ Diagnostic and recovery ports (USB Micro-B connectors)
- ▶ Micro-SD Card slot
- ▶ Custom specific application programming on request

Additional Features

- ▶ On-board M.2 SSD socket PCIe® x4, up to 2280 size
- ▶ PCIe® packet switch 6-port x4 Gen3
- ▶ Option PCIe® optical cabling via 4 x MPO/MTP connectors (Samtec FireFly™)
- ▶ Option master/slave configuration, connected via PCIe® optical fiber or Twinax copper cable
- ▶ Attachment of peripheral devices with PCIe® x4 interface such as high resolution cameras
- ▶ Option wireless connection w. GC102 mezzanine card (dual M.2 Wi-Fi 6, M.2 WWAN 4G/5G)
- ▶ Custom specific mezzanine board design on request
- ▶ Custom specific base board design on request

Power Requirements

- ▶ DC Input, wide range 9V-57V
- ▶ Power consumption tbd W max.
- ▶ Fast acting chip fuse (PCB soldered type)
- ▶ Protected against reverse polarity
- ▶ ESD protection (TVS)
- ▶ Common mode input filter
- ▶ M12-A 5-pin front panel power connector
- ▶ Option ATX auxiliary power connector (front)
- ▶ Option terminal block 3.5mm pitch 4-position screw lock (side of PCB) power input

Technical Features

Applications

- ▶ Artificial Intelligence CUDA® based edge computing
- ▶ Distributed multi-processing, real-time AI
- ▶ PCIe® based long range optical cabling to slave ECUs and peripheral devices
- ▶ Industrial networks - IIoT
- ▶ Ethernet based cable and wireless networking
- ▶ 4G/5G networking
- ▶ Data acquisition
- ▶ Kiosk systems, information panels
- ▶ Dual 4k display solution, independent operation
- ▶ Single display or headless applications
- ▶ Rugged environments
- ▶ Vehicles, transportation, harvesting, construction machines
- ▶ Robotics
- ▶ Autonomous machines
- ▶ Machine learning
- ▶ Surveillance, mapping
- ▶ ADAS test equipment

Environmental, Regulatory

- ▶ Designed & manufactured in Germany
- ▶ ISO 9001 certified quality management
- ▶ Long term availability
- ▶ Rugged solution
- ▶ RoHS compliant
- ▶ Operating temperature -40°C to +85°C (industrial temperature range)
- ▶ Storage temperature -40°C to +85°C, max. gradient 5°C/min
- ▶ Humidity 5% ... 95% RH non condensing
- ▶ Altitude -300m ... +3000m
- ▶ Shock 15g 0.33ms, 6g 6ms
- ▶ Vibration 1g 5-2000Hz
- ▶ EC Regulatory EN55024, EN55032, EN62368-1 (CE)
- ▶ MTBF tbd years

all items may be subject to technical changes w/o further notice

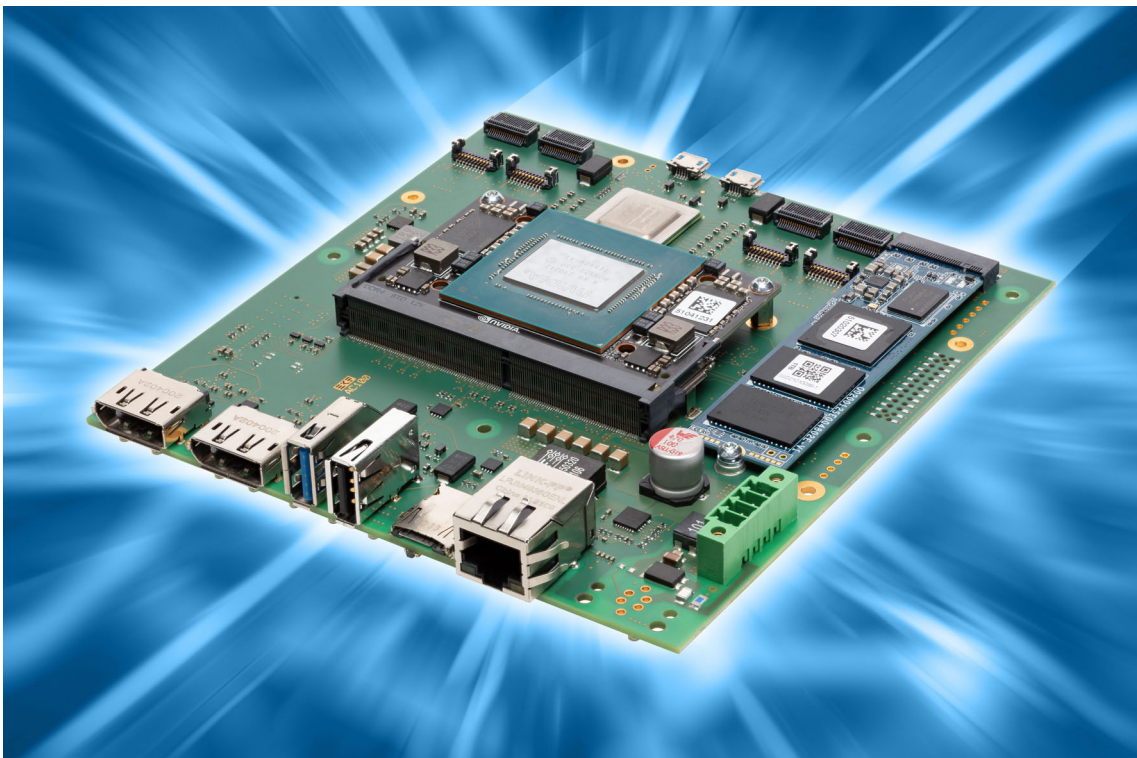
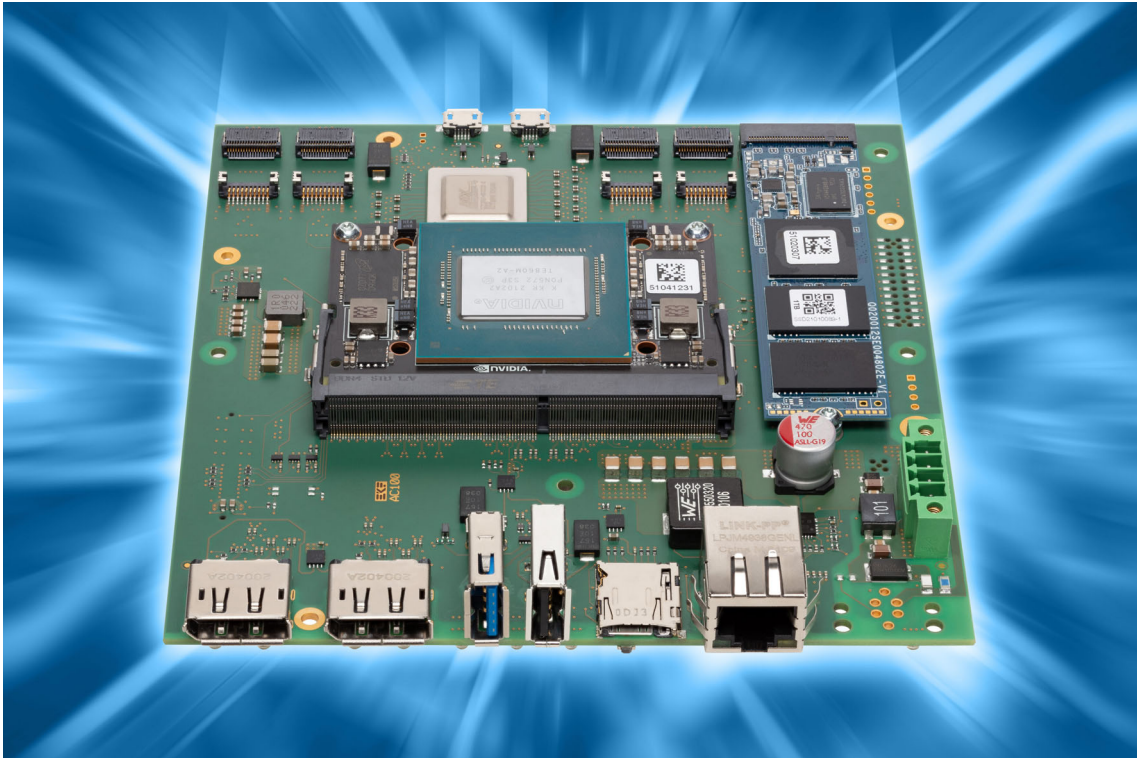



Block Diagram

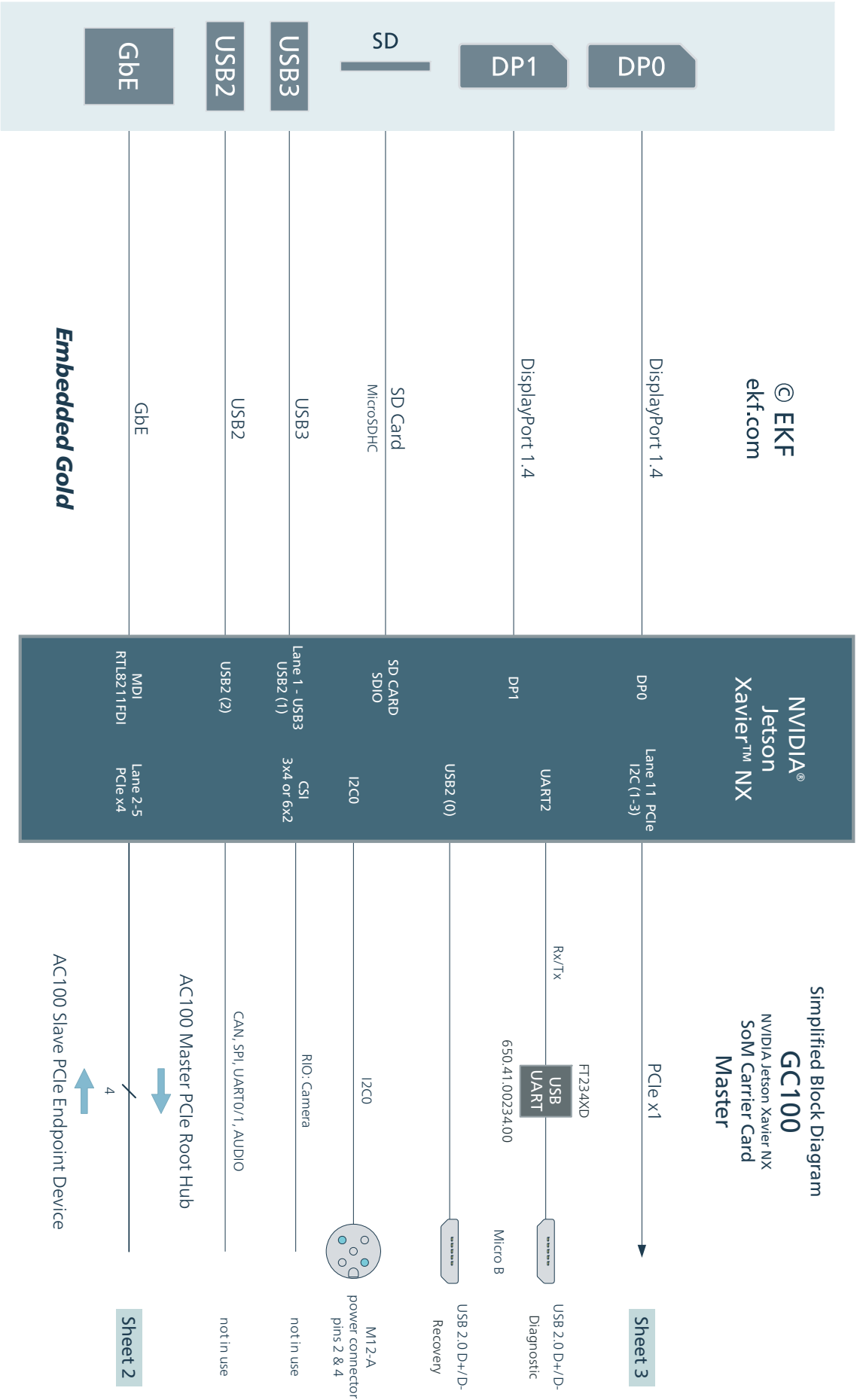

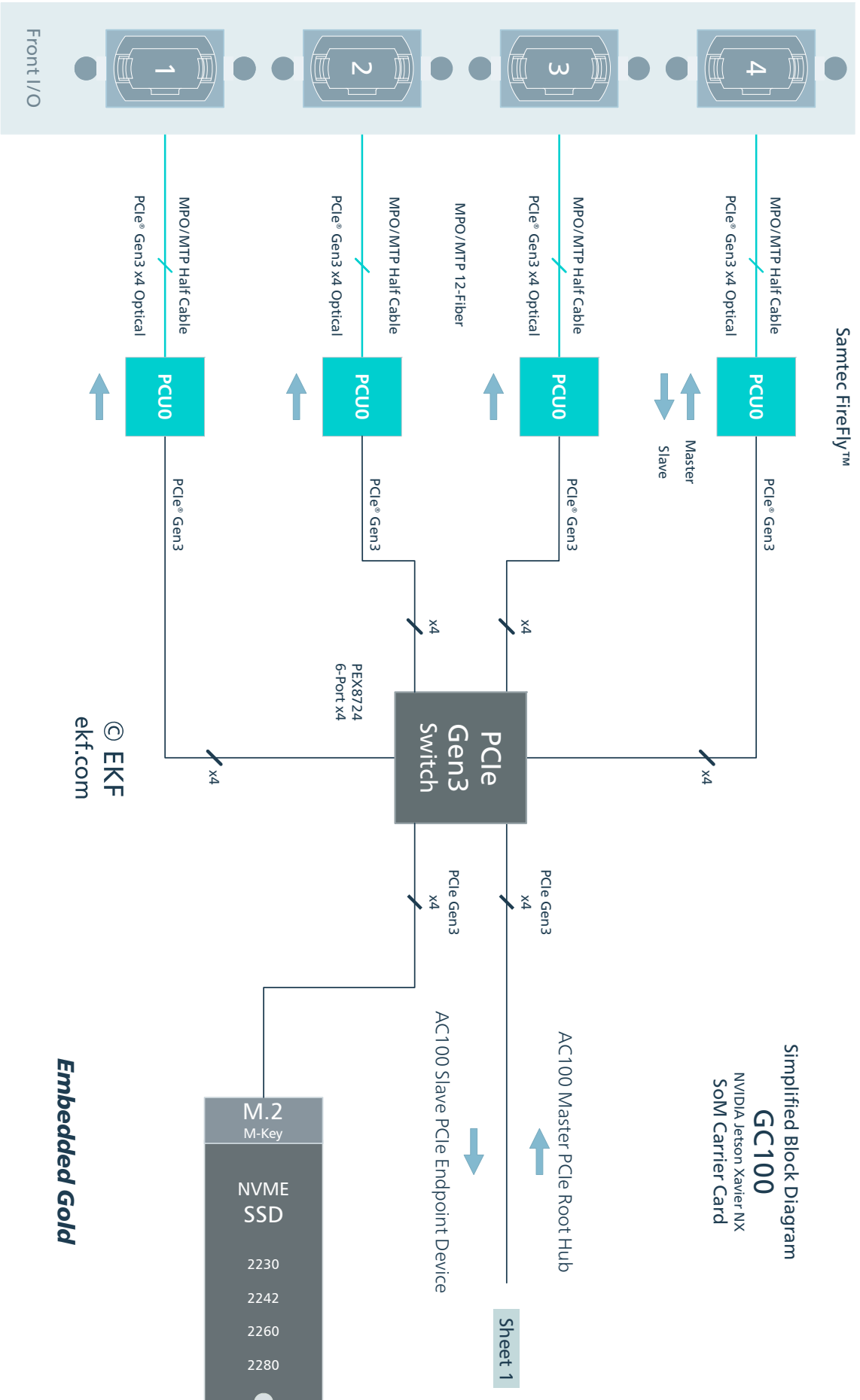

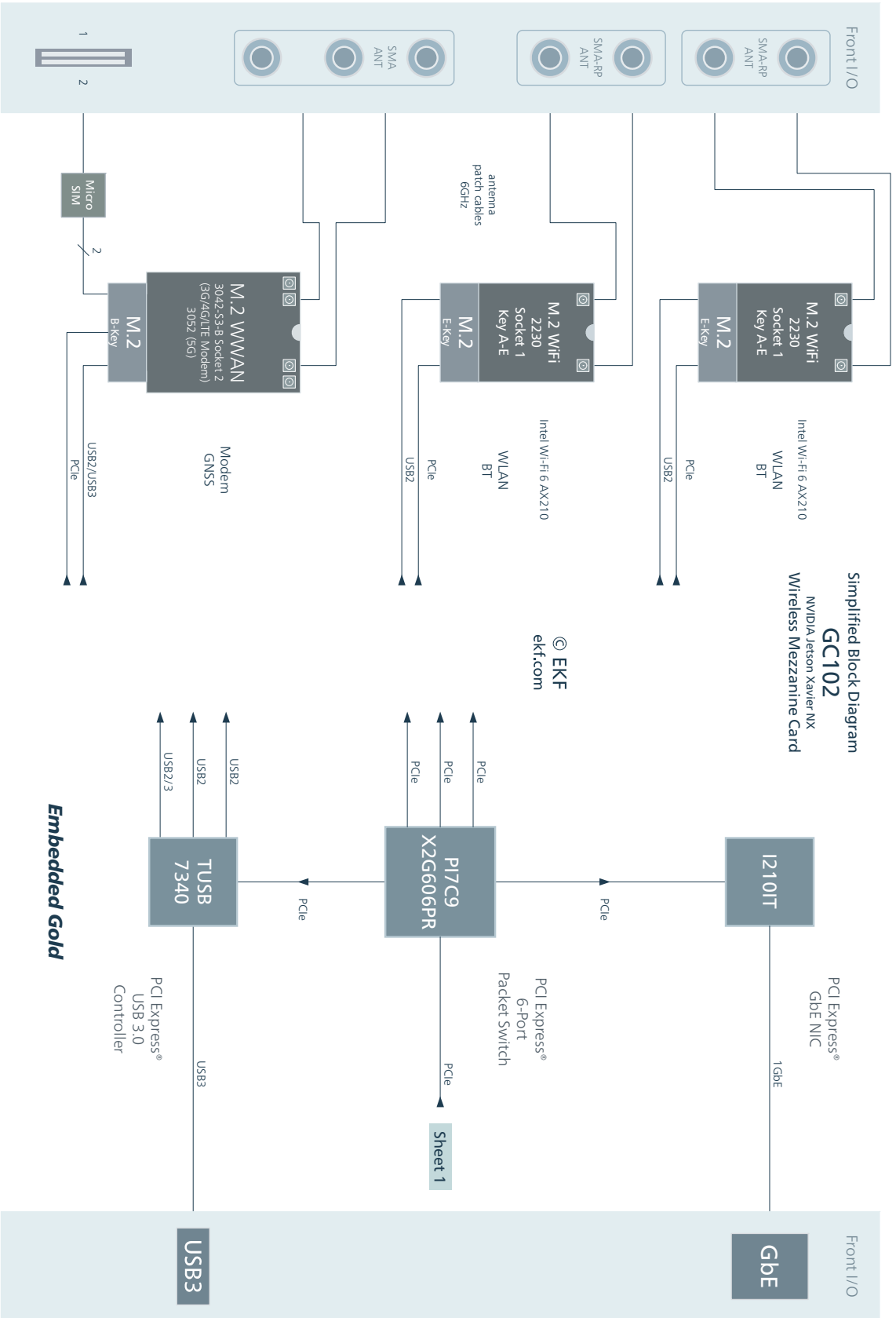

Dimensions

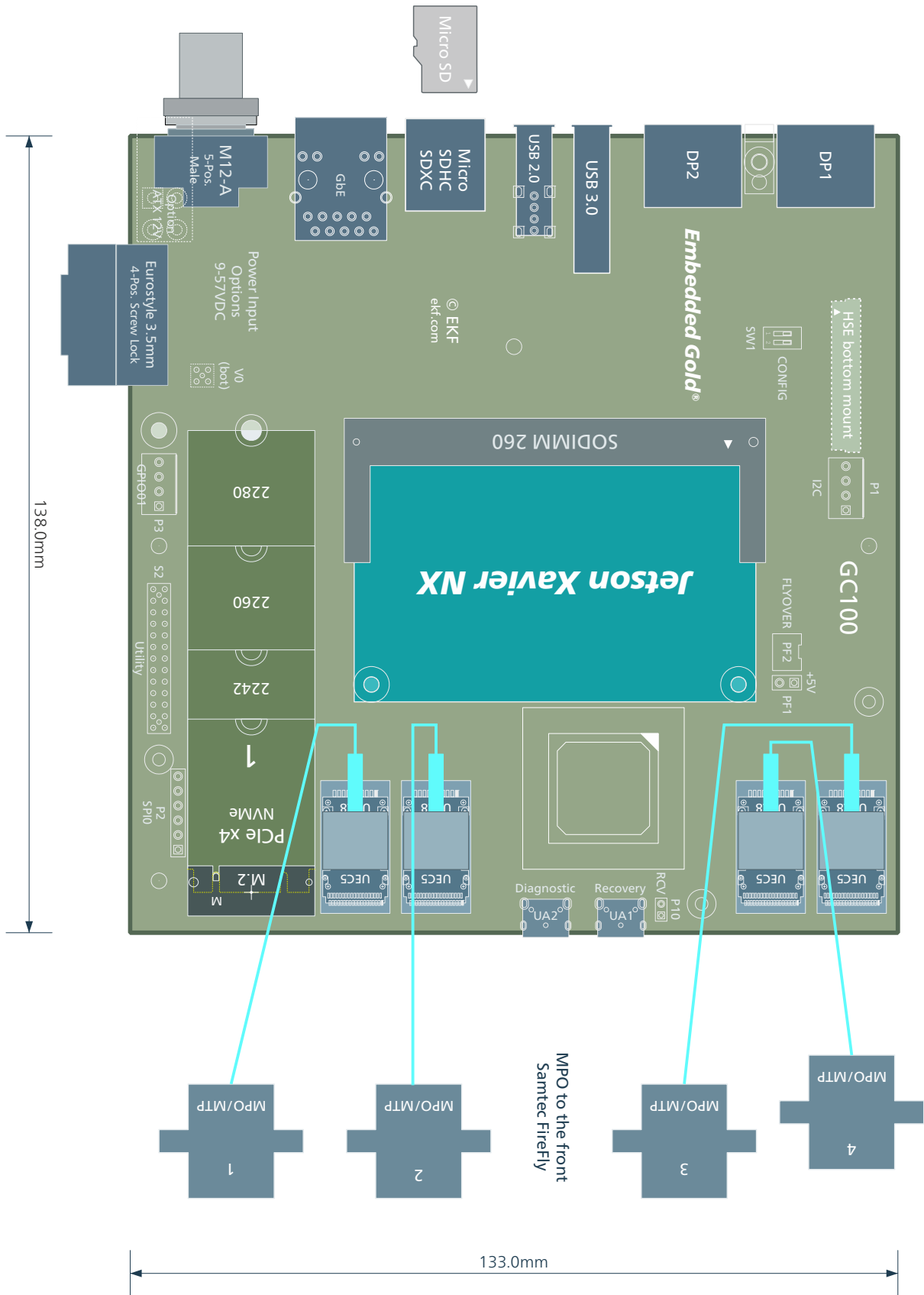

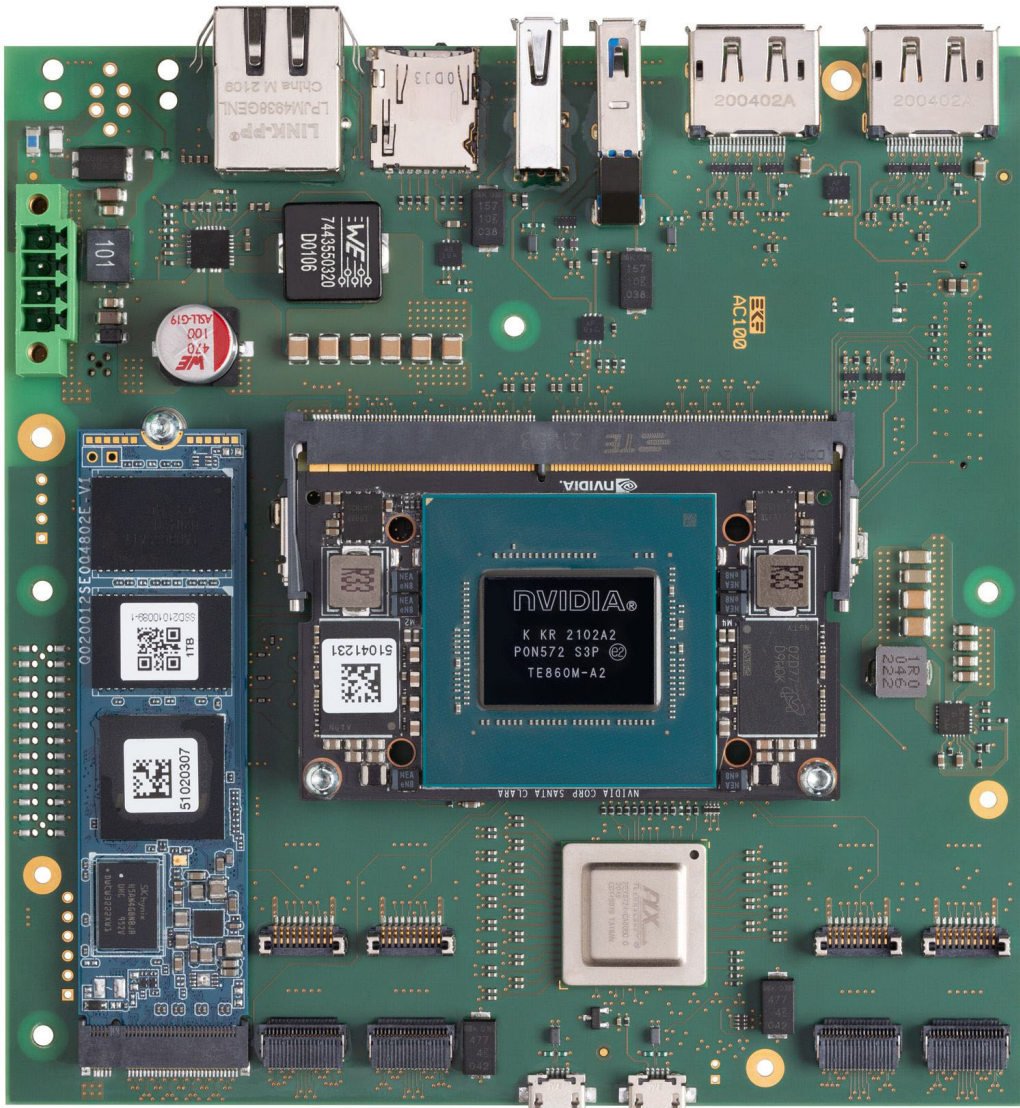

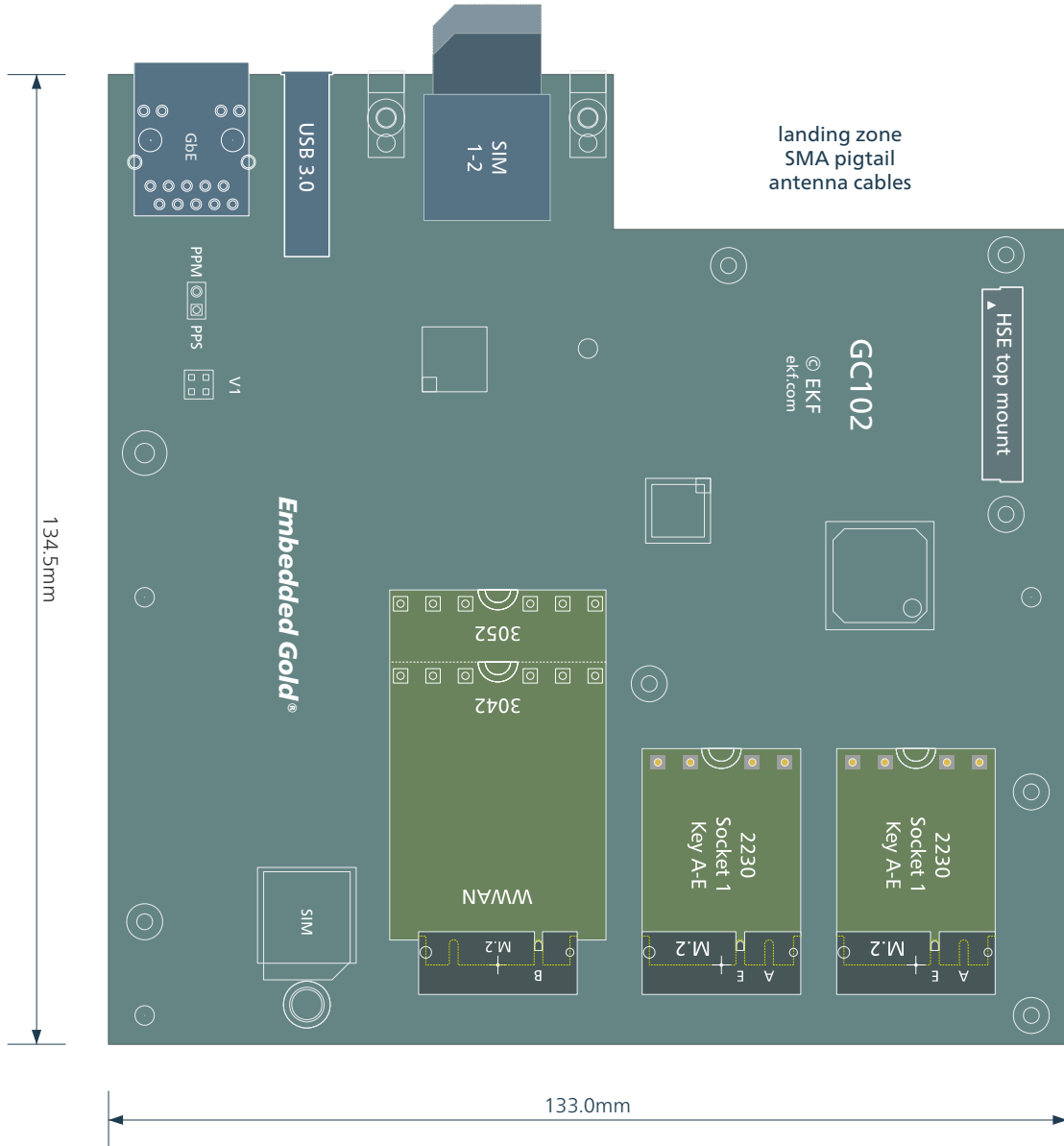

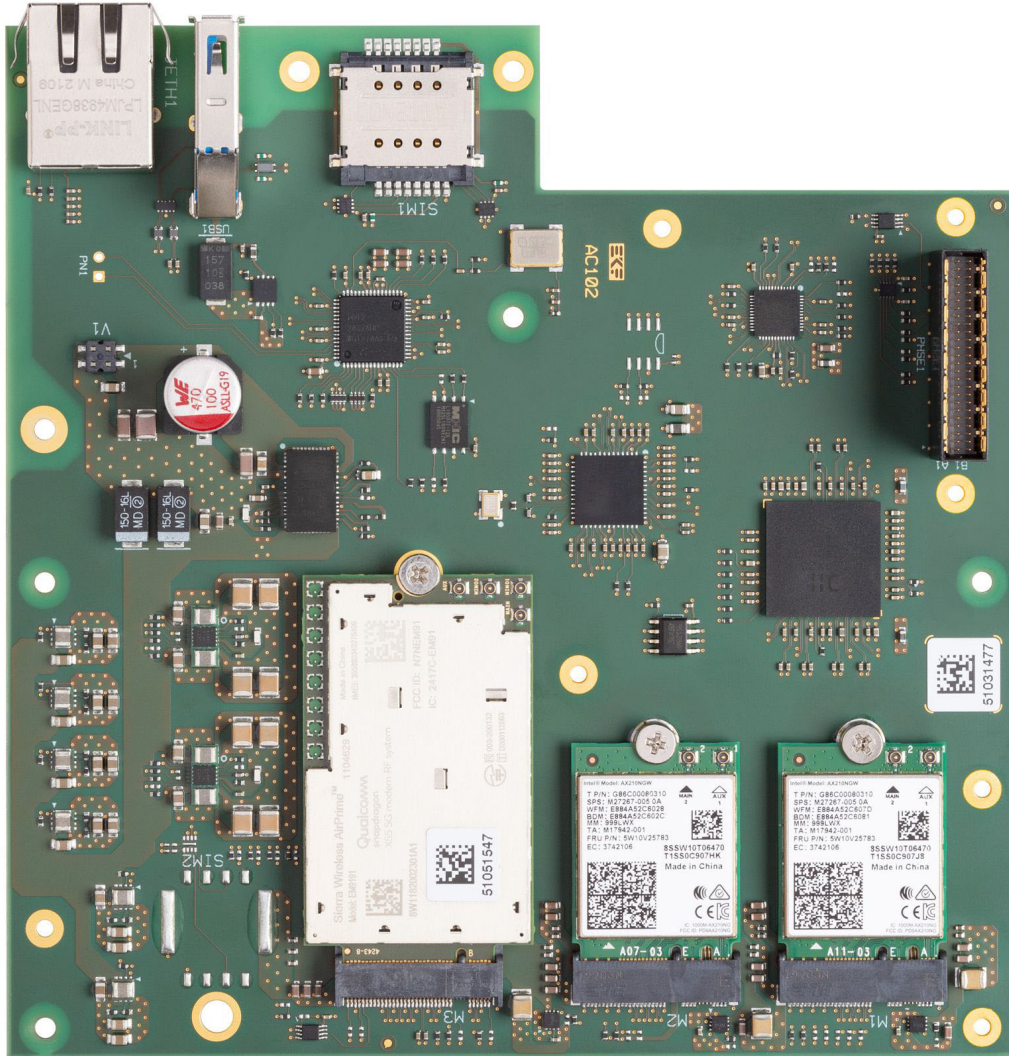

Recommended Front Panel Design

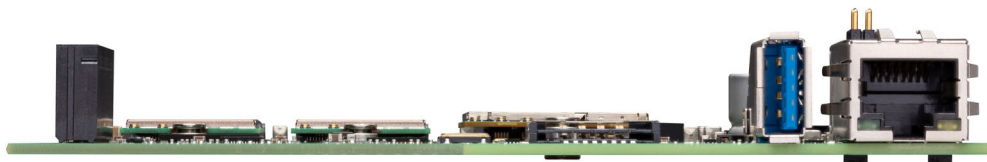
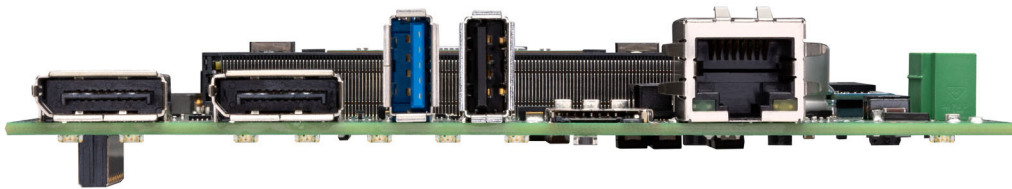
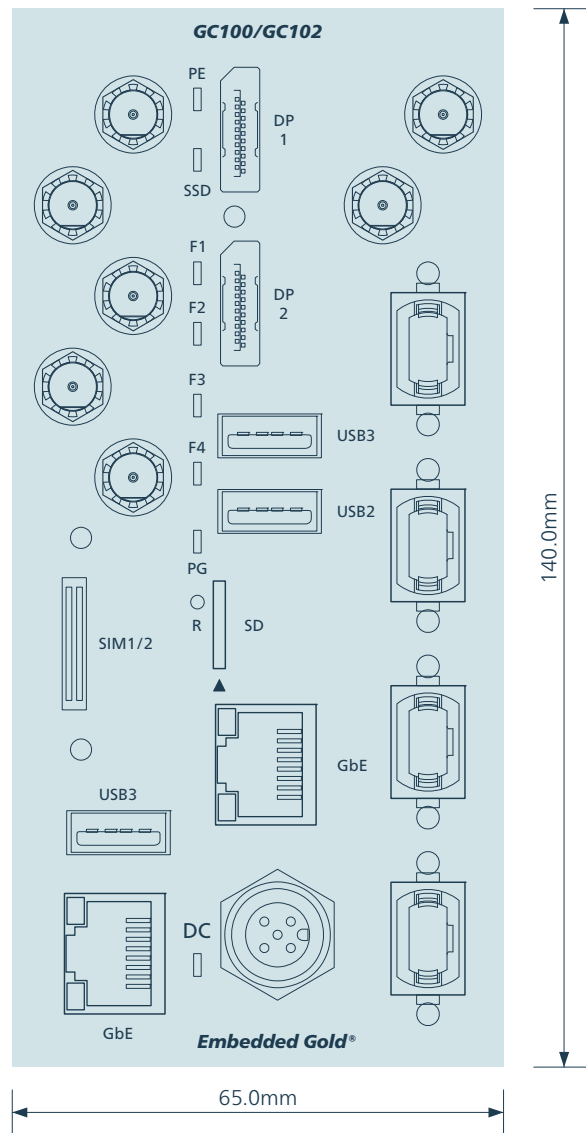

M12 Power Connector Pin Assignment

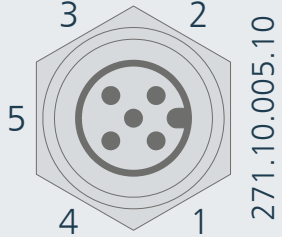
PCB Connector M12-A 5-Position Male 4A/Pin	
	1 +V
	2 RSV
	3 GND
	4 RSV
	5 FE (Shield)

V=9-57VDC

Mating Pigtail Cable Assemblies 1.5m w. Female Straight Plug	
EKF	271.10.505.22.015
Phoenix Contact	1669822
Tyco (TE)	2273035-1

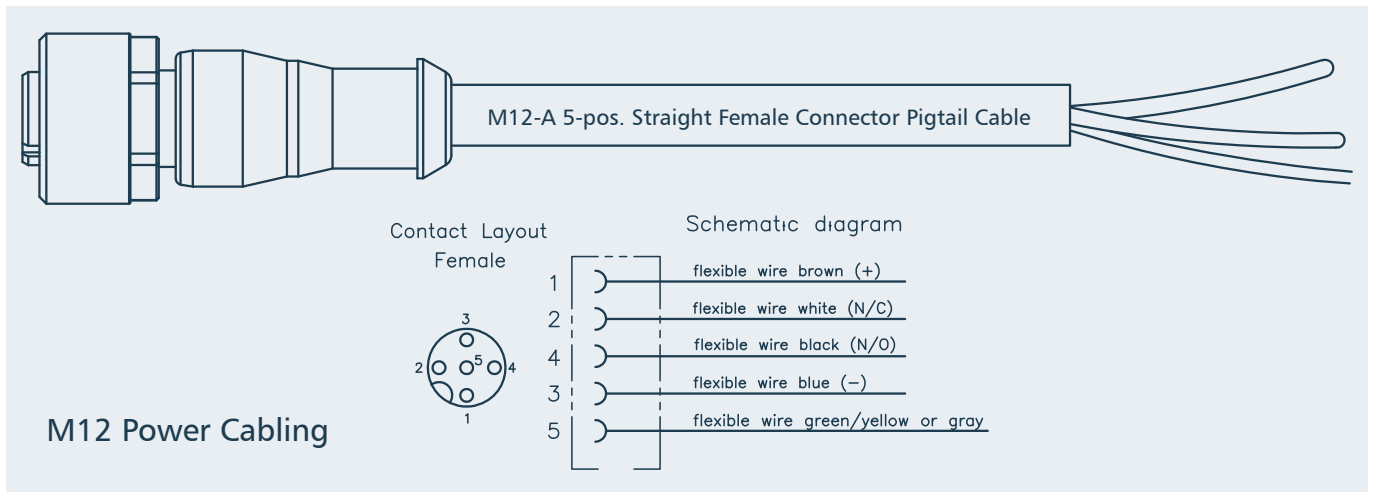

pre-assembled standard pigtail cables - wires #2 and #4 may not in use (reserved)

Mating DIN Rail Power Supply	
EKF	352.1.075.24.1
Meanwell	NDR-75-24, 75W 24VDC/3.2A

Option Terminal Block Power Connector Pin Assignment

3.50mm 4-Position Terminal Block 8A/Contact		
<p>245.35.04.00</p> <p>1 2 3 4</p>	<p>V=9-57VDC</p>	1 +V
		2 GND
		3 RSV
		4 FE (Shield)

Mating Plugs w. Screw Lock	
EKF	245.35.04.20
FCI Amphenol	20020000-C041B01LF
Molex	39504-0004
Phoenix Contact	1847071
Tyco	284510-4

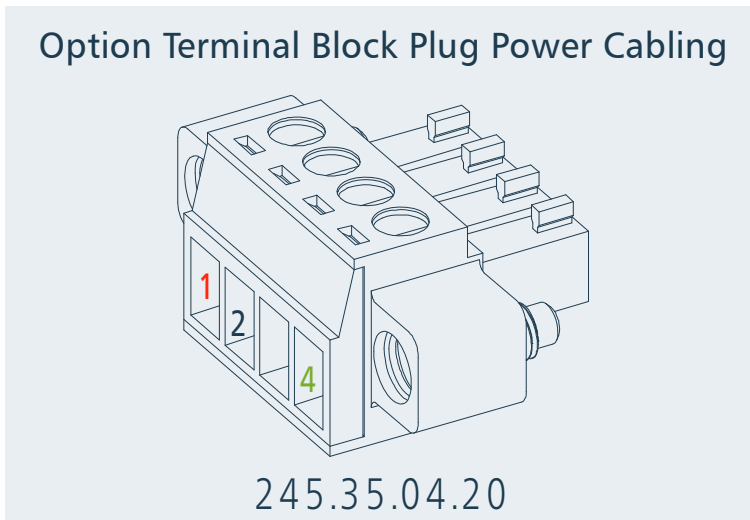

Option ATX Auxiliary Power +12V

As an alternate, the PCB can be equipped with a 2x2 pin 4.2mm pitch dual row wire to board header (ATX 12V 4-pin), for attachment of a suitable cable assembly to the front. Many PC power supplies are provided with a mating cable harness.

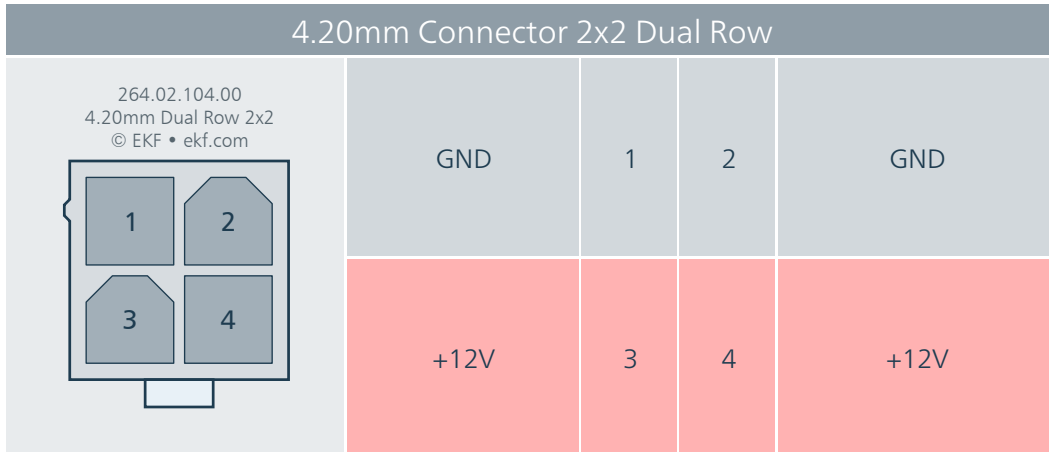

Mating cable connectors are available e.g. from Molex, under the Mini-Fit® Jr.™ brand. A suitable housing would be e.g. the Molex part #0039013042, to be used with crimp terminals e.g. Molex part #0039000060 (18-24 AWG). Other manufacturers for 4.20mm style connectors are e.g. Würth and TE.

The M12-A power connector and the ATX power connector are exclusive manufacturing alternates.

Mezzanine Interface GC100/GC102

HSE (GC100) • High Speed Expansion (Bottom Mount)

Carrier card connector 8mm female ERNI Microspeed 275.90.08.068.01

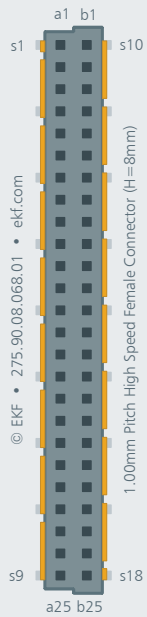

PCIE1_CLKREQ#	a1	b1	GND
PCIE1_TX0P	a2	b2	RSV
PCIE1_TX0N	a3	b3	RSV
GND	a4	b4	GND
PCIE1_RX0N	a5	b5	RSV
PCIE1_RX0P	a6	b6	RSV
GND	a7	b7	GND
RSV	a8	b8	RSV
RSV	a9	b9	RSV
GND	a10	b10	GND
RSV	a11	b11	RSV
RSV	a12	b12	RSV
GND	a13	b13	GND
I2S1_DOUT (1.8V)	a14	b14	I2C0_SCL (3.3V)
I2S1_DIN (1.8V)	a15	b15	I2C0_SDA (3.3V)
GND	a16	b16	GND
I2S1_FS (1.8V)	a17	b17	I2C1_SCL (3.3V)
I2S1_SCLK (1.8V)	a18	b18	I2C1_SDA (3.3V)
GND	a19	b19	GND
WWAN_MOD_RST#	a20	b20	PCIE_CLK_P
PCIE1_RST#	a21	b21	PCIE_CLK_N
+3.3V	a22	b22	+5V
+3.3V	a23	b23	+5V
RSV	a24	b24	RSV
RSV	a25	b25	RSV

HSE (GC102) • High Speed Expansion (Top Mount)

Mezzanine card connector 10mm male ERNI Microspeed 275.90.10.068.51

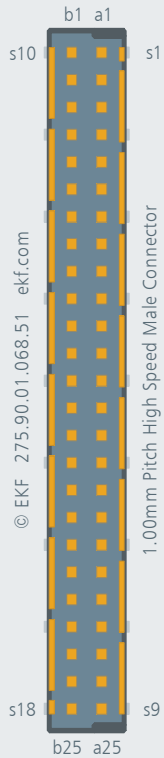

GND	b1	a1	GND
RSV	b2	a2	PCIE_1TP
RSV	b3	a3	PCIE_1TN
GND	b4	a4	GND
RSV	b5	a5	PCIE_1RN
RSV	b6	a6	PCIE_1RP
GND	b7	a7	GND
RSV	b8	a8	RSV
RSV	b9	a9	RSV
GND	b10	a10	GND
RSV	b11	a11	RSV
RSV	b12	a12	RSV
GND	b13	a13	GND
I2C0_SCL (3.3V)	b14	a14	RSV
I2C0_SDA (3.3V)	b15	a15	RSV
GND	b16	a16	GND
I2C1_SCL (3.3V)	b17	a17	RSV
I2C1_SDA (3.3V)	b18	a18	RSV
GND	b19	a19	GND
PCIE_CLK_P	b20	a20	WWAN_MOD_RST#
PCIE_CLK_N	b21	a21	PLTRST#
RSV	b22	a22	RSV
RSV	b23	a23	RSV
RSV	b24	a24	RSV
RSV	b25	a25	RSV

V0 (GC100) V1 (GC102) • DC High Voltage (Bottom/Top Mount)
 2x2 2.00mm Socket Pass Through w. Stacker >2A/Pin

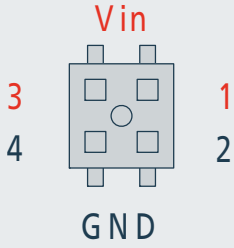
 <p>The diagram shows a square socket with four pins. The top-left pin is labeled '3', the top-right '1', the bottom-left '4', and the bottom-right '2'. Above the socket is the label 'Vin' and below it is 'GND'.</p>	V_{IN} 9-57VDC	1	2	GND
	V_{IN} 9-57VDC	3	4	GND

On-Board Connectors & Switches

S2 • Utility Connector • GC100 2x13 2.0mm Socket Signals from Jetson, 3.3V Signal Level Shifted			
SLEEP_WAKE#	1	2	GND
+5V	3	4	UART0_TXD
MOD_SLEEP#	5	6	UART0_RXD
SHUTDOWN_REQ#	7	8	UART0_RTS#
GPIO01	9	10	UART0_CTS#
USB2_EN	11	12	+3.3V
GND	13	14	SD_PWRON
USB3_EN	15	16	+3.3V
WWAN_RST#	17	18	GND
GPIO09	19	20	GND
USB3_OC#	21	22	+5V
GPIO12	23	24	FAN_TACH_5V
GPIO13	25	26	FAN_PWM_5V

P1 • I ² C • GC100 Male Locking Pin Header 2.54mm WR-WTB 5V Level Shifted	
1	+5V
2	I2C0_SDA
3	I2C0_SCL
4	GND

P2 • SPI • GC100 Pin Header 2.54mm (not stuffed) Signals from Jetson	
1	SPI0_SCK
2	SPI0_MISO
3	SPI0_MOSI
4	SPI0_CS0#
5	SPI0_CS1#
6	+3.3V

P3 • GPIO01 • GC100 Male Locking Pin Header 2.54mm WR-WTB 3.3V Level Shifted	
1	RSV
2	RSV
3	GPIO01
4	GND

PF1 • FireFly • GC100 Pin Header 2.54mm (not stuffed) Camera Power Jumper to FireFly Sockets Pins B8/B9	
1	+5V
2	+CAM_PWR

PF2 • FireFly • GC100 Pin Header 2x5 1.27mm (not stuffed) FireFly Sockets Pins A12/B12/A11/B11			
ISOGND FireFly 1-4 A11 B11	1	2	GND
GPO FireFly 1 B12	3	4	GPI FireFly 1 A12
GPO FireFly 2 B12	5	6	GPI FireFly 2 A12
GPO FireFly 3 B12	7	8	GPI FireFly 3 A12
GPO FireFly 4 B12	9	10	GPI FireFly 4 A12

P10 • Force Recovery • GC100 Pin Header 2.0mm (not stuffed) Wired to Jetson	
1	FORCE_RECOVERY#
2	GND

PN1 • PPS/PPM • GC102 Pin Header 2.54mm (not stuffed) Wired to I210-IT NIC	
1	PPS SDP2
2	PPM SDP3

DSW1 • PCIe Configuration • GC100 DIP-Switch Wired to Jetson & PEX8724 PCIe® Switch	
Slider 1 = ON	Force Root Port
Slider 1 = OFF	Root/Endpoint Control via Jetson GPIO07
Slider 2 = ON	Switch EEPROM 1 enabled
Slider 2 = OFF	Switch EEPROM 2 enabled

TSW1/2 • Tactile Switches • GC100 Tactile Switches Bottom Mount, Wired to Jetson	
TSW1 (Front of PCB)	SYS_RESET#
TSW2 (PCB Rear Edge)	FORCE_RECOVERY#

SIM Card Holders

The GC102 is equipped with three SIM card holders, a dual slot Mini SIM 2FF socket for 25mmx15mm cards, and optionally a Micro SIM 3FF card socket for a 15mmx12mm SIM card.

The sockets were constructed for 0.76mm thick Mini and Micro SIM cards. However, often SIM cards come as pre-cut assembly with a Nano SIM in its center, which is defined for a thickness of only 0.67mm. In rare cases, this may lead to contact problems.

As a professional solution, the Nano SIM 4FF can be put into an adapter for use with sockets designed for 2FF or 3FF SIMs. A simple workaround to improve contact pressure would be to attach a suitable self-adhesive Kapton label on the SIM card assembly back side, in order to bridge the gap of 0.09mm.



© Raimond Spekking / Wikimedia Commons



Nano SIM 4FF to 3FF/2FF Adapters

Ordering Information

For popular GC100/GC102 SKUs please contact sales@ekf.de



Embedded Gold

Document No. 9985 • © EKF • 4 August 2022

EKF Elektronik GmbH
Philipp-Reis-Str. 4 (Haus 1)
Lilienthalstr. 2 (Haus 2)
59065 HAMM
Germany



Phone +49 (0)2381/6890-0
Fax +49 (0)2381/6890-90
Internet www.ekf.com
E-Mail sales@ekf.com