

- 2x Gb Ethernet with RJ-45
- 3x USB 3.2 / 1x USB 2.0 ports
- 1x RS-232/485, 1x RS-232 serial port via RJ-12 and pin header
- 1x HDMI 2.0a/b with audio support
- Camera adapter module connector supports a variety of cameras with 8 CSI lanes available
- 16x GPIO 3.3V/5V
- 1x CAN 2.0 port
- Minicard socket with PCIe, USB, and SIM socket
- M.2 E-key 2230 socket
- M.2 M-Key 2280/2242 socket
- Daughterboard expansion connector with PCIe and USB3 links
- Compact size 4.33 x 3.35" / 110 x 85mm
- 5VDC input (Nano), 7-20VDC input (NX) auto-switching
- -25 to +80 deg. C operation

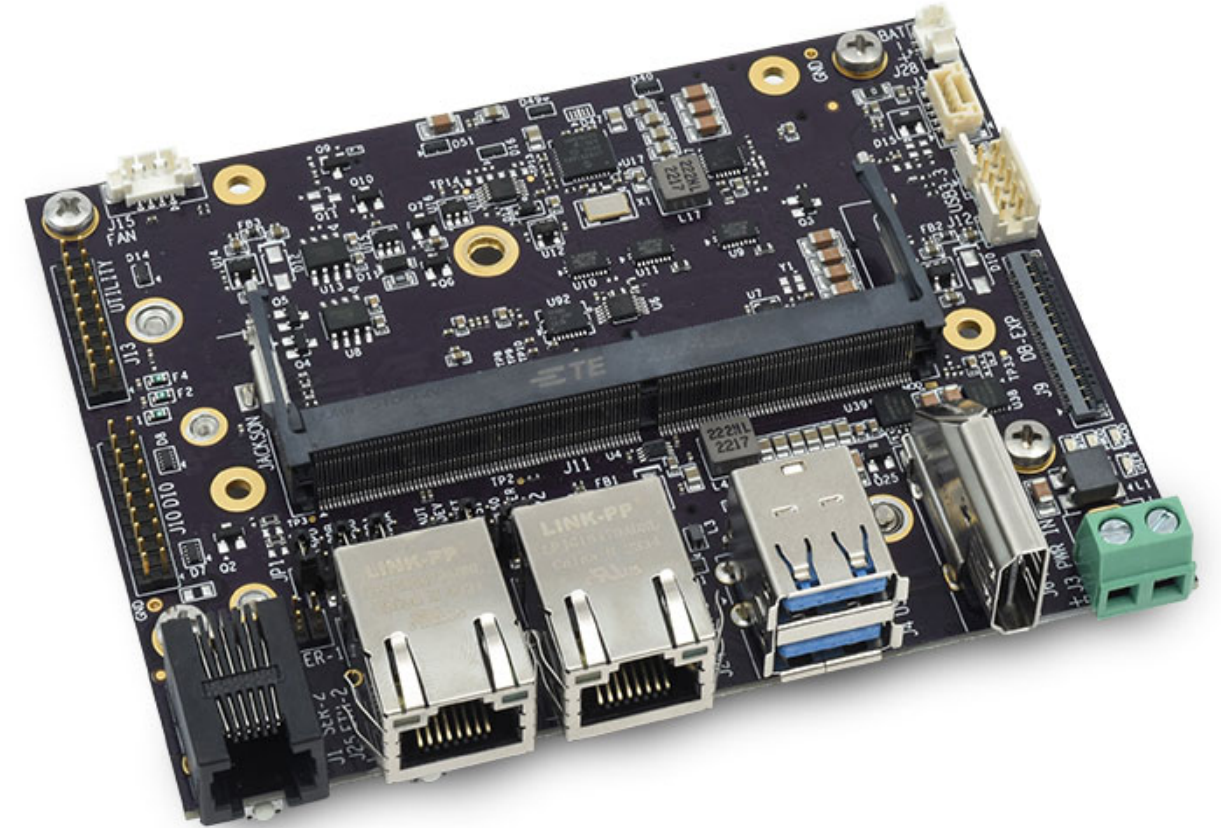

Model	JAX-BB01	JAX-BB02
Gb Ethernet	2	1
Daughterboard	Yes	No
Availability	Stock	MOQ

Available as carrier board alone or complete assembly with Jetson, fan sink, and OS installed

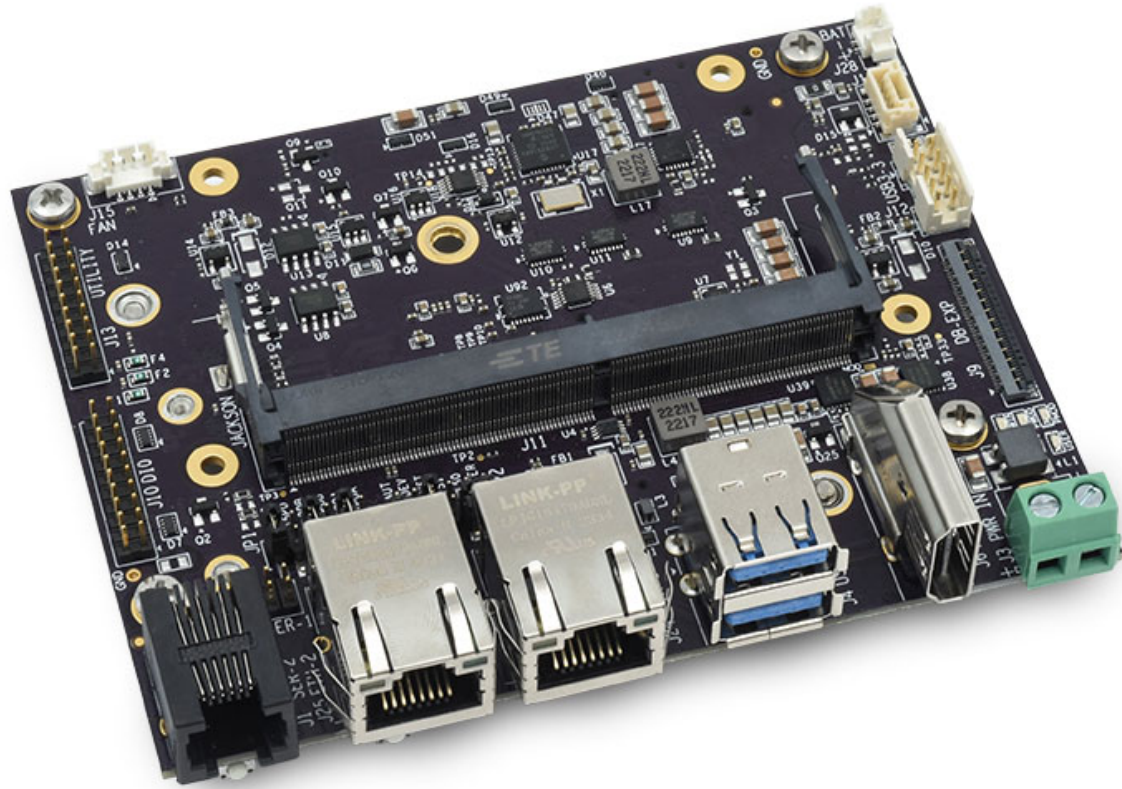

**JAX-BB01**  
*Carrier Board*

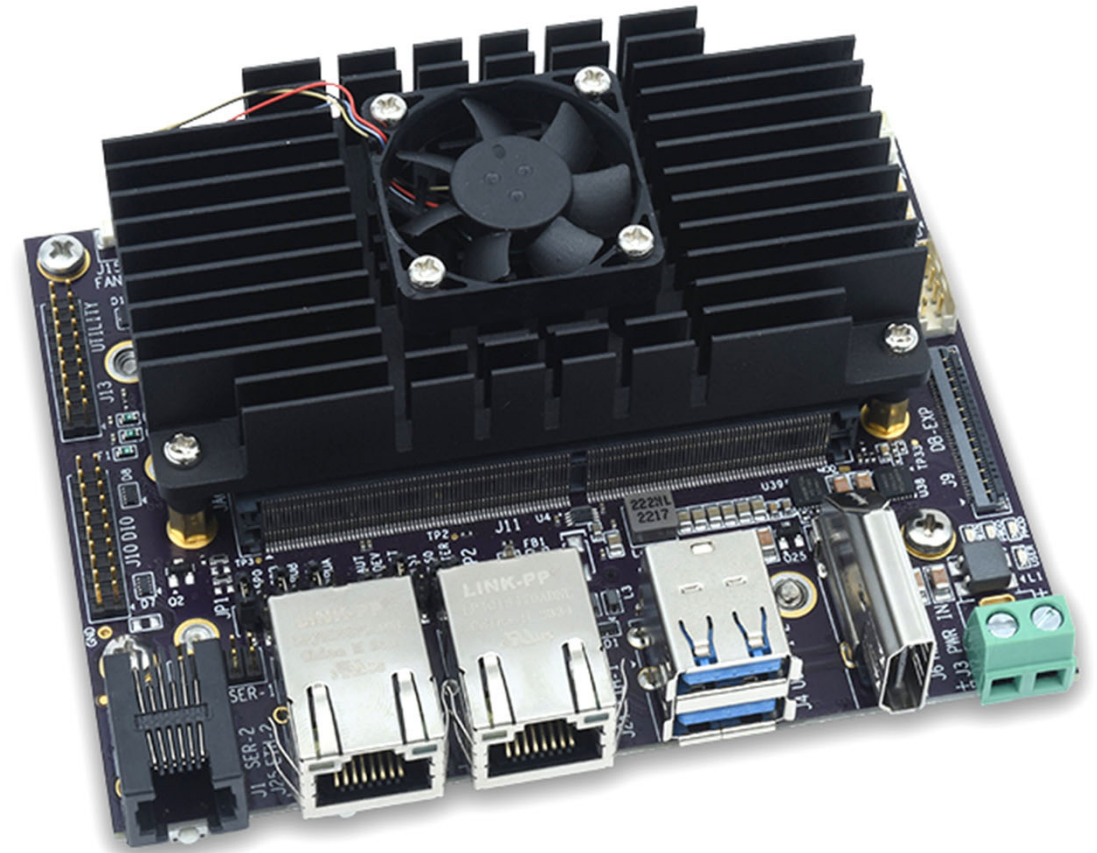

**JAX-ASY-xxx**  
*Integrated assembly*

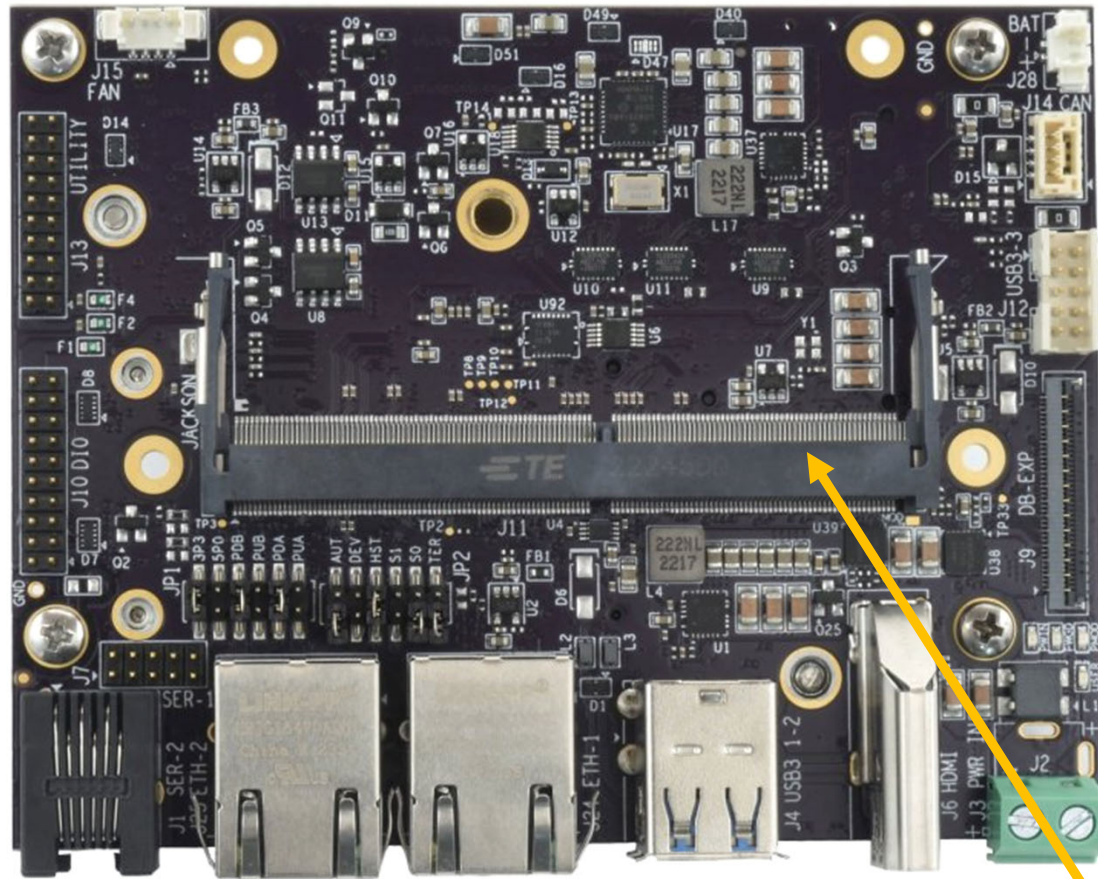

Top side for Jetson



Orin NX

M.2 M Key

M.2 E Key

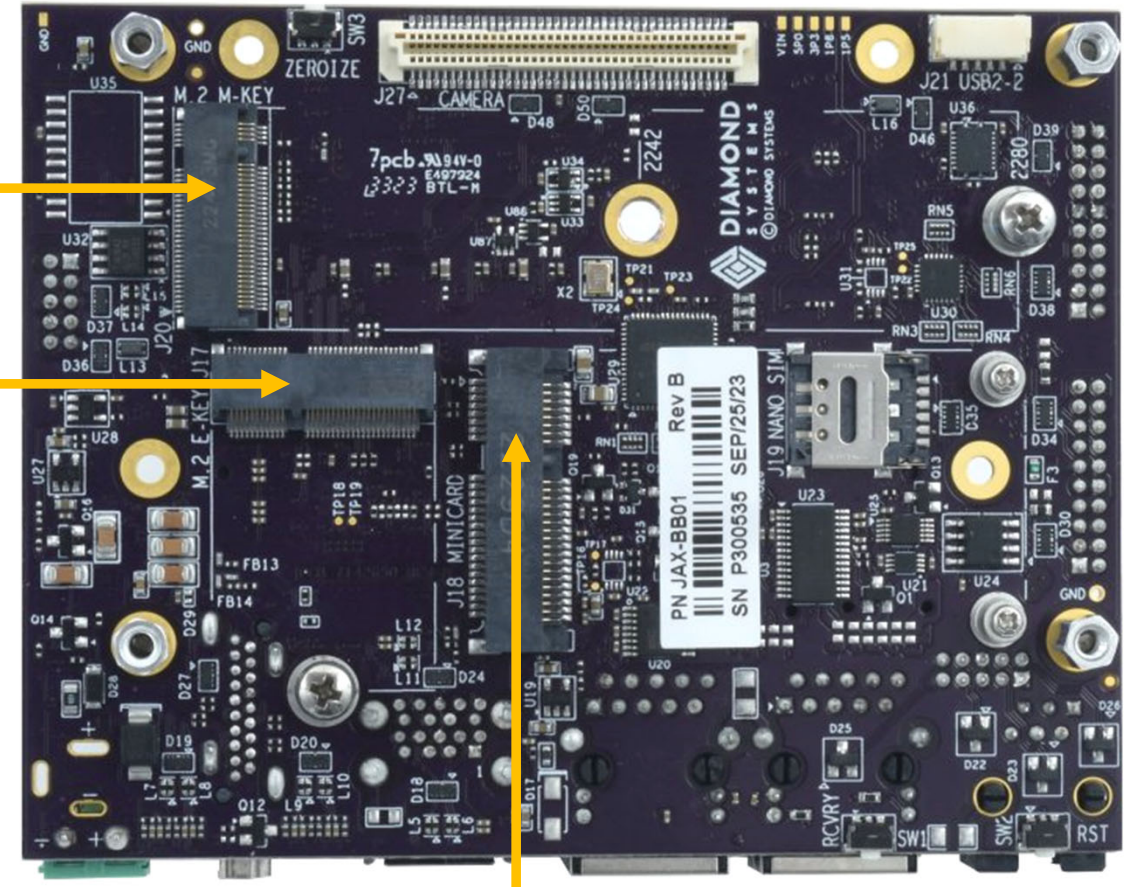

Minicard

Bottom side for expansion

Daughterboard provides additional I/O with PCIe and USB expansion

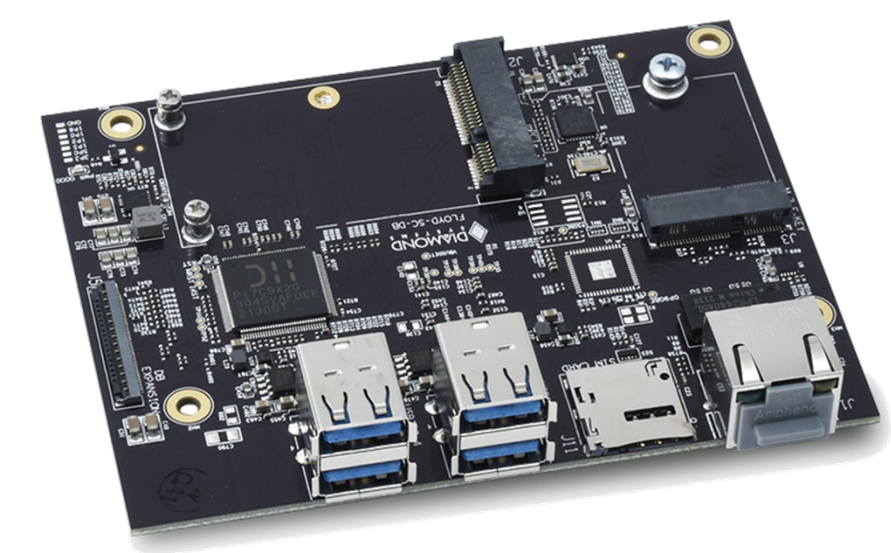
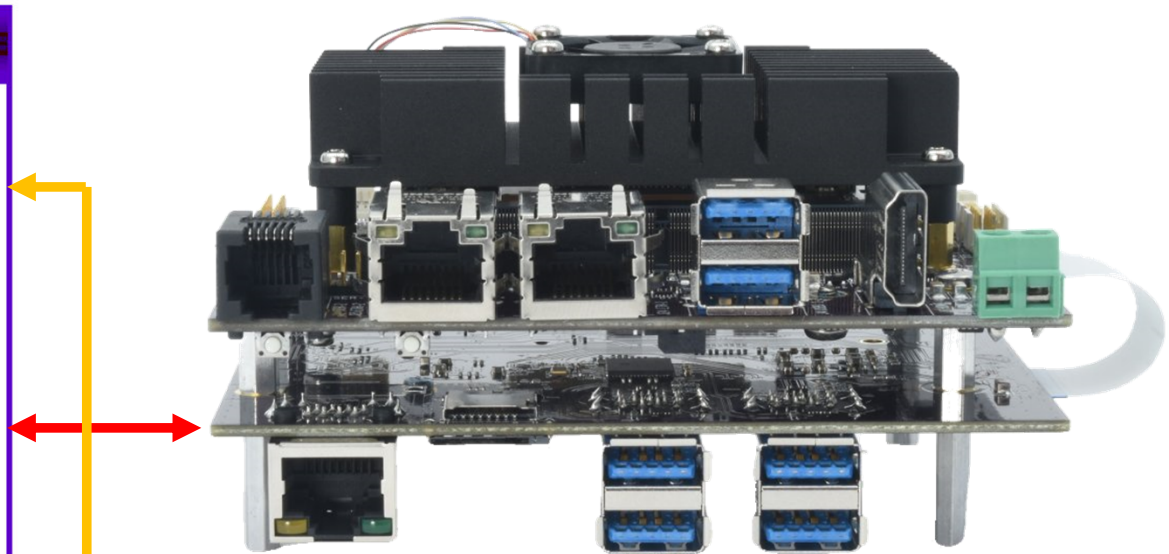
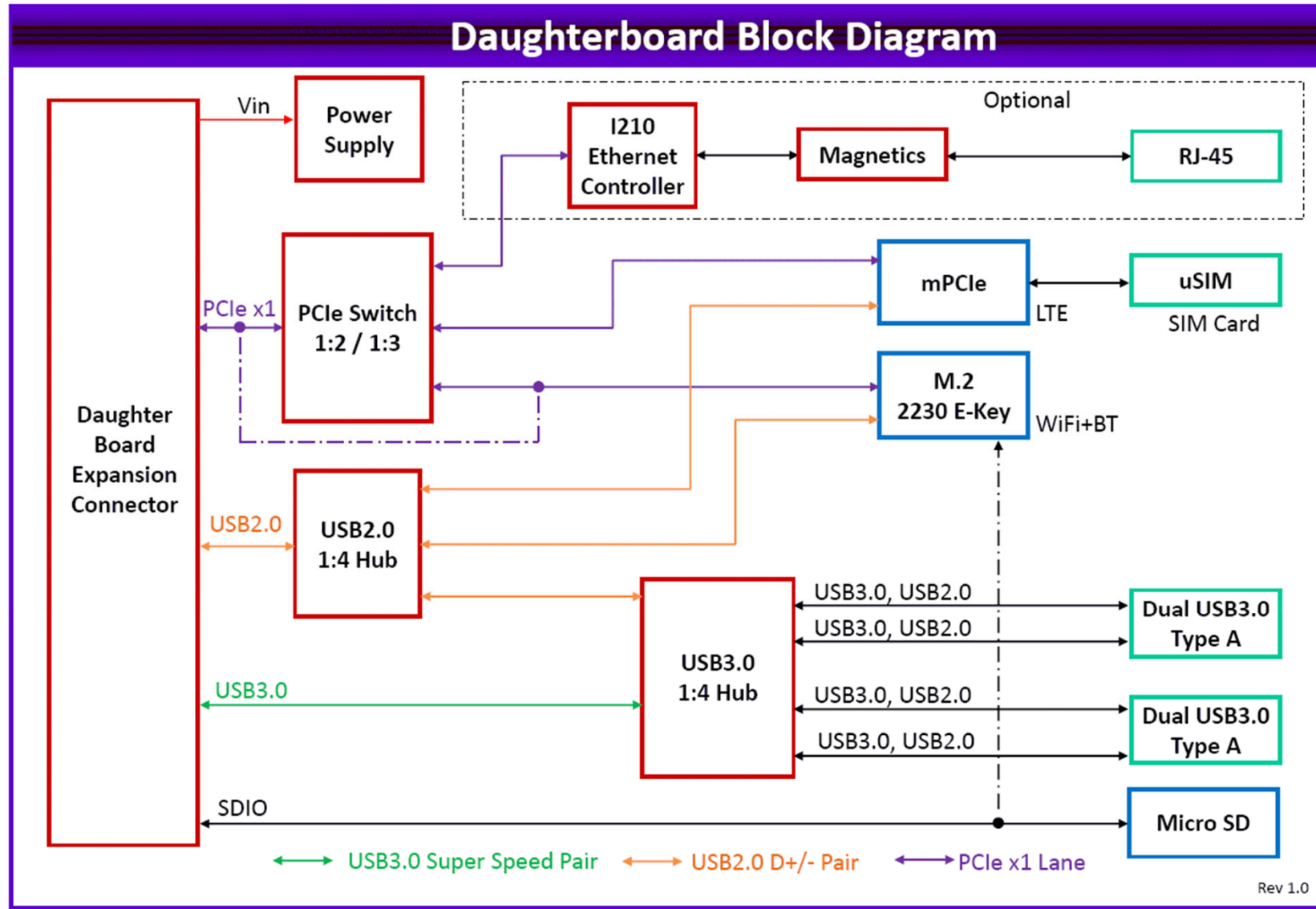

Added features

# JetBox Jackson

New!

Orin NX / Orin Nano Industrial Grade System

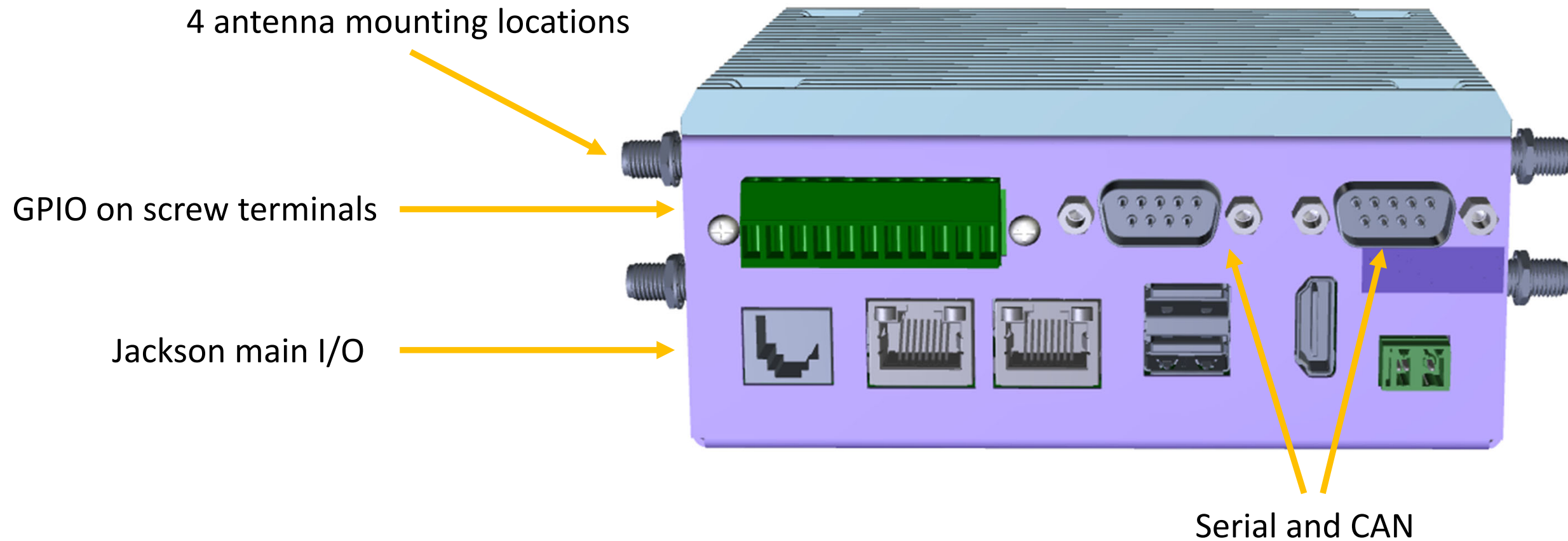

- 124 x 99 x 56mm / 4.9 x 3.9 x 2.2" (Same size as JetBox-FloydSC)
- Temperature range TBD (-25 to 70C?)